

B.D.I.[®]

BURST
DISC
INDICATOR

WHEN NOTIFICATION OF
PRESSURE RELIEF
IS ESSENTIAL



The B.D.I.[®] (Burst Disc Indicator) Alarm System is designed for use with Continental Disc rupture discs. The B.D.I. Alarm System signals the system operator when a rupture disc has burst to relieve an overpressure or vacuum condition.

Continental Disc Rupture Discs with the B.D.I. Alarm System

The heart of the system is the B.D.I. Alarm Strip. Upon disc rupture, the B.D.I. Alarm Strip is severed, disrupting the flow of electric current through the strip. The change in the electric circuit status can be monitored in a control room, or an optional alarm monitor is available from Continental Disc to warn of a rupture disc burst and/or activate appropriate equipment.

The B.D.I. Alarm System should be specified:

- When warning of pressure relief is essential for plant safety
- When immediate notice is needed of relief of an overpressure or vacuum condition to indicate process malfunction
- When indication is vital that a rupture disc has burst and toxic substances are venting
- When a signal is required to initiate an automatic function, process change or shut down procedure
- When loss or contamination of product will occur if a rupture disc is not replaced immediately
- When monitoring of rupture discs is important in hard-to-reach locations

Proven Design

The B.D.I. Alarm Strip is designed to break when its corresponding rupture disc bursts. Continental Disc's design has been proven through years of testing, both in the field and in our ASME accepted flow testing laboratory. This testing has proved the reliability of the alarm strip when used with Continental Disc Corporation rupture discs. The B.D.I. Alarm Strip does not affect the life or performance of the rupture disc.

The B.D.I. Alarm Strip is carefully designed and manufactured with the following features in mind:

- Resistant to chemical attack and corrosion
- Usable over a wide range of temperatures
- Easily replaceable upon disc rupture
- Compatible with standard design Continental Disc Corporation rupture discs

ATEX Directive Compliant

The B.D.I. Alarm Strip and the MTB-700 Alarm Monitor have been certified for use in "potentially explosive atmospheres" according to the requirements of the European Union, ATEX Directive 2014/34/EC. ATEX type approval and quality assurance notification certificates are available on our website at www.contdisc.com.

B.D.I. Alarm System // Operating Schematic

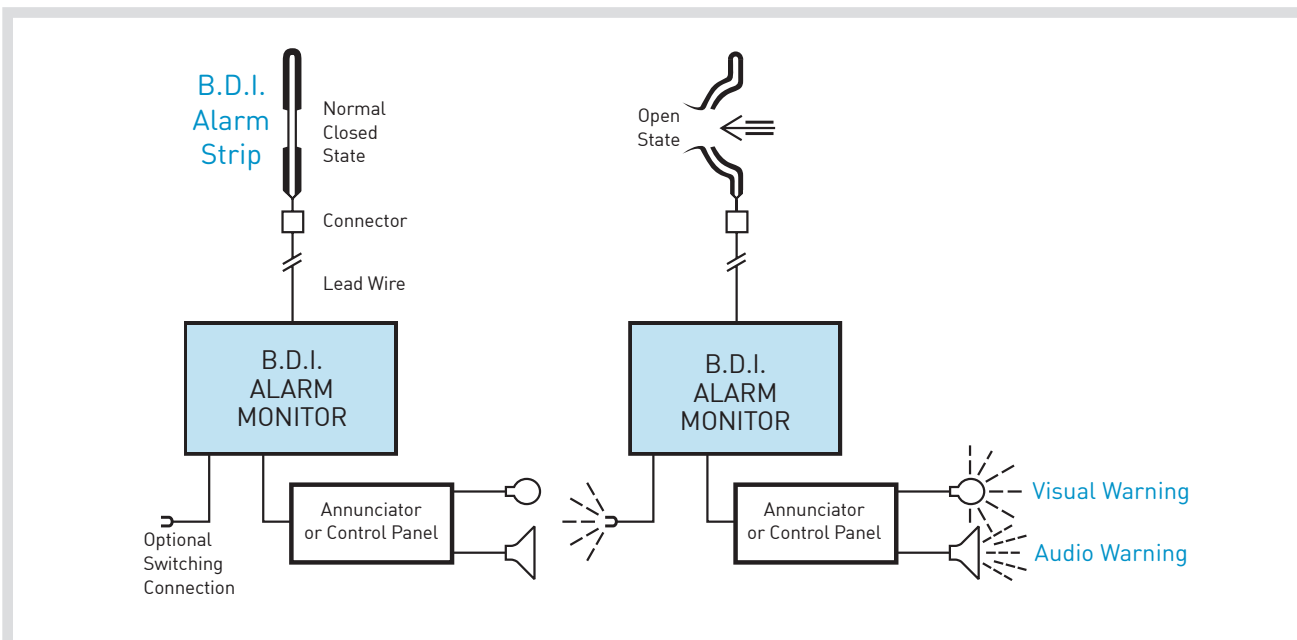

TYPICAL APPLICATIONS

Rupture disc applications which can incorporate a B.D.I. Alarm System are limitless and found across a broad spectrum of industries and processes, and where an instant notification of an overpressure or vacuum event is required

Relief Valves

Isolating relief valves with a rupture disc protects internal valve parts from corrosive media. The B.D.I. Alarm System signals when a disc rupture relieves an overpressure condition, enabling the operator to correct the process and restore protection to the relief valve.

Installing a rupture disc with a B.D.I. Alarm Strip on the outlet side of a relief valve notifies the operator when a valve has relieved. This is an especially important application when handling toxic or corrosive substances.

Processing Vessels

Rupture discs with the B.D.I. Alarm System are used on processing tanks and vessels requiring protection from overpressure or vacuum conditions. The system warns when a disc ruptures.

Chemical Reactors

When processing temperatures and pressures are critical, the B.D.I. Alarm System gives immediate warning when service is interrupted due to relief of an overpressure condition.

Tank Transports

The B.D.I. Alarm System signals immediately when a rupture disc has burst, thereby releasing product to the atmosphere.

Pipeline Pumping Stations

Rupture discs relieve pressure buildup in pumping stations caused by blocked pipelines. The system signals as relief occurs and can trigger shutdown of pumping systems.

Fermentation Vessels

Products requiring gaseous blankets to prevent spoilage or product contamination must be protected from the atmosphere. Immediate warning of disc rupture permits quick corrective action, reducing loss of product and expensive gases.

Storage/Silo Tanks

Storage tanks which damage easily from overpressure or vacuum conditions are protected with the CAL-VAC® Rupture Disc or POS-A-SET® Rupture Disc. Often these discs are located in hard-to-reach areas. The B.D.I. Alarm System warns immediately when the rupture disc bursts.

Distillation Equipment

Distilled products must be free from contamination. Operator warning is vital when a product batch is contaminated from the intake of an outside atmosphere during vacuum relief. The B.D.I. Alarm System provides the needed warning.

THE HEART OF THE SYSTEM ...THE B.D.I. ALARM STRIP

The B.D.I. Alarm Strip is designed to break when its corresponding rupture disc bursts. This creates an open circuit which is detected by the B.D.I. Alarm Monitor, or other suitable monitoring device.

Design Specifications

- Maximum current: 50 milliamps
- Maximum voltage: 24 VDC RMS
- Operating temperature range: -40°F to +400°F (-40°C to +204°C)
- Minimum relieving pressures:

MINIMUM PRESSURE FOR UNIVERSAL B.D.I.			
NOMINAL SIZE		PRESSURE	
in	mm	psig	barg
1	25	15	1,03
1½	40	10	0,69
2	50	4	0,28
3	80	2.5	0,17
4	100	2.5	0,17
6 - 36	150 - 900	1	0,07

The UNIVERSAL Low Pressure B.D.I. is available for sizes 1" - 4" for pressures down to 1 psig (0,07 barg)

Components

The B.D.I. Alarm Strip is composed of copper conductors adhered to a thin strip of KAPTON® film. Tantalum conductors are available for some applications. The conductors pass through the rupture disc seating area for Integral B.D.I. designs or flange gasket facing for Universal B.D.I. designs, terminating with your choice of a molded plug or bare leads.

The B.D.I. Alarm Strip is manufactured as either an Integral B.D.I. or a Universal B.D.I. design, dependent upon the rupture disc product it is to mate with (See table 1 on next page).

The Universal B.D.I. design is compatible with rupture disc/holder assemblies designed to install between bolted flange standards including ASME, DIN, JIS, see Table 2 for available flange classes. Custom designs are also available, contact the factory for details. Standard gaskets are asbestos free fiber-bound material or an optional GYLON® 3500 silica filled PTFE material.

Continued...



Integral B.D.I. on Disc with Sanitary Design Holder



Insert Design Assembly

RUPTURE DISC / B.D.I. ALARM STRIP TYPE SELECTION	
INTEGRAL B.D.I.	UNIVERSAL B.D.I.
SANITRX HPX®	HPX®
SANITRX LP®	ULTRX®
SANITRX®	LOTRX®
CAL-VAC®	MICRO X®
POS-A -SET®	Composite
ENVIRO SEAL I & II	Standard
Vent Panel	[all others not listed]
GRAFSSERT®	
SEALSERT	
CDC, CDCV for (SF)	
PL, PLV for (SF)	

BOLTING CLASSES AVAILABLE FOR UNIVERSAL B.D.I. ALARMS			
SIZE	ASME	DIN	JIS
1" - 1½"	150#, 300#/600#	PN 10/40	2/5K, 10/20K, 30/40K
2" - 3"	150#, 300#/600#	PN 10/40	2/5K, 10K, 16/20K, 30/40K
4", 6"	150#, 300#	PN 10/16, PN 25/40	2/5K, 10K, 16/20K, 30K, 40K
8" - 12"	150#, 300#	PN 10, PN 16, PN 25, PN 40	2/5K, 10K, 16/20K, 30K, 40K
14", 16"	150#	PN 10, PN 16	2/5K, 10K, 16/20K, 30K, 40K
18"	150#		5K, 10K, 16/20K
20", 24"	150#	PN 10, PN 16	5K, 10K, 16/20K
28"	150#	PN 10, PN 16	5K, 10K, 16K, 20K
30"	150#		5K, 10K, 16K, 20K
32", 36"	150#	PN 10, PN 16	5K, 10K, 16K, 20K

Linking the B.D.I. Alarm Strip to the monitoring system is the B.D.I. Lead Wire Assembly. A two-pin bullet plug protects the terminals at the connecting point against moisture. It is abrasion resistant, flexible, and highly weather-resistant. An alternate bare leads end of shielded cable is also available in 6 ft (2m), 10 ft (3m) and 20 ft (6m) lengths.

Use the B.D.I. Lead Wire Assembly to connect the B.D.I. Alarm Strip with a Standard Plug B.D.I. Connection to the B.D.I. Alarm Monitor. The B.D.I. Lead Wire Assembly is available in 6, 10, 20, 50, 75, 100, 200 and 300 foot lengths with a Standard Plug B.D.I. Connector and a Lead Wire Strain Relief Device on one end and bare leads on the other.

End User Suggestions

When there is a distance of 15 feet or more of unsupported cable between the B.D.I. Alarm Strip and the B.D.I. Alarm Monitor, a junction box is recommended. This box protects the alarm strip from the weight of the long cable, as well as protecting the cable connection from environmental elements.

Shielded cable should be used for cable runs between a junction box and the B.D.I. Alarm Monitor to prevent triggering of a false alarm.

HPX RUPTURE DISC ASSEMBLY WITH UNIVERSAL B.D.I.



B.D.I. LEAD WIRE ASSEMBLY AND CAL-VAC RUPTURE DISC WITH INTEGRAL B.D.I.

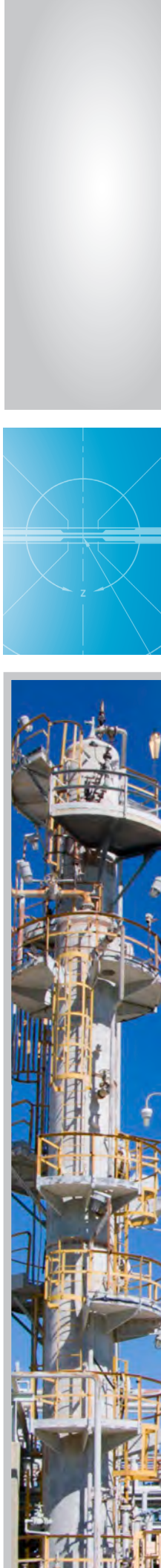

B.D.I. ALARM MONITOR FUNCTIONS, FEATURES & OPTIONS

The B.D.I. Alarm System uses a normally closed electrical circuit. A continuous signal flows between the B.D.I. Alarm Strip and the Alarm Monitor under normal conditions. Once the rupture disc bursts, the Alarm Strip breaks, opening the electrical circuit.

B.D.I. Alarm Monitors contain replaceable modules with individual channel relays. Each channel relay connects to one alarm strip. As the rupture disc and B.D.I. Alarm Strip break, a specific relay is actuated, sending a signal to the control panel.

Control panels, annunciators, light panels or other signalling devices can be used to warn of a ruptured disc. The B.D.I. Alarm System is versatile to adapt to a variety of warning devices. Individual relay circuitry allows the user to monitor several B.D.I. Alarm Strips at once. Pumps, valves, and other systems may also be activated to respond to an overpressure or vacuum situation by the break of a specific B.D.I. Alarm Strip.

Definitions

As used in the MTB-700, BB-100A and BB-400A Alarm Monitor descriptions:

INTRINSICALLY SAFE is defined as: "Apparatus, including wiring, in which any spark or thermal effect produced either normally or in specified fault conditions ...is incapable under test conditions of causing ignition of a specified mixture of flammable or combustible material in air."

MTB-700 ALARM MONITOR WITH HPX ASSEMBLY AND UNIVERSAL B.D.I.



The MTB-700 Alarm Monitor incorporates intrinsically safe galvanically isolated barriers, approved for use in many countries worldwide. An MTL5018AC barrier is utilized on the MTB-700 Alarm Monitor with a 120/240 VAC input power option. An MTL5018 barrier is utilized on the MTB-700 Alarm Monitor with the 24 VDC input power option. Upon disc rupture, these barriers activate signals and/or output relays to warn operators and actuate pumps, valves, or other equipment connected to the system.



Model Overview

MODELS AVAILABLE	MTB-700	BB-100A	BB-400A
Dry contacts for remote alarms	YES	YES	YES
Output relay type	DPDT Form C	SPDT Form C	SPDT Form C
Relay max current	5 A @ 240 VAC Resistive 5 A @ 24 VDC Resistive 1/8 HP @ 120/240 VAC, 7 A maximum carry current	2 A @ 120 VAC Resistive 1 A @ 120 VAC Inductive 2 A @ 24 VDC Inductive	2 A @ 120 VAC Resistive 1 A @ 120 VAC Inductive 2 A @ 24 VDC Inductive
Intrinsically safe field circuit	YES	YES	YES
Barrier type	galvanically isolated	zener diode	zener diode
Enclosure rating	NEMA 4, 4X, 12, 13	NONE	NONE
Operating temperature range	-4°F to +113°F (-20°C to +45°C)	-40°F to +104°F (-40°C to +40°C)	-40°F to +104°F (-40°C to +40°C)
Reset mode (latching, non-latching)	latching only	either available	either available
Output current to BDI Strip	7 VDC @ 22 MA	6 VDC @ 0.1 MA	6 VDC @ 0.1 MA
Remote master test contacts	YES	NO	NO
Remote master reset contacts	YES	YES	YES
Barrier Certifications	FM, ATEX, CSA, IECEx	None	None

Model Options

Monitor Model	# of Discreet Channels	Audio/Visual Alarm	Input Power	Part Number
MTB-700	2	Yes	24 VDC +/- 2 V	M2A0000V024
			120 VAC 50/60 Hz	M2A0000V120
			240 VAC 50/60 Hz	M2A0000V240
		No	24 VDC +/- 2 V	M2S0000V024
			120 VAC 50/60 Hz	M2S0000V120
			240 VAC 50/60 Hz	M2S0000V240
	4	Yes	24 VDC +/- 2 V	M4A0000V024
			120 VAC 50/60 Hz	M4A0000V120
			240 VAC 50/60 Hz	M4A0000V240
		No	24 VDC +/- 2 V	M4S0000V024
			120 VAC 50/60 Hz	M4S0000V120
			240 VAC 50/60 Hz	M4S0000V240
BB-100A	2	No	115 VAC 50/60 Hz, 230 VAC 50/60 Hz or 12 VDC +/- 2 V	520000300
BB-400A	8	No	115 VAC 50/60 Hz, 230 VAC 50/60 Hz or 12 VDC +/- 2 V	520000400



